

axxera™

CD Receiver

Made for
iPod iPhone



Installation & Owner's Manual

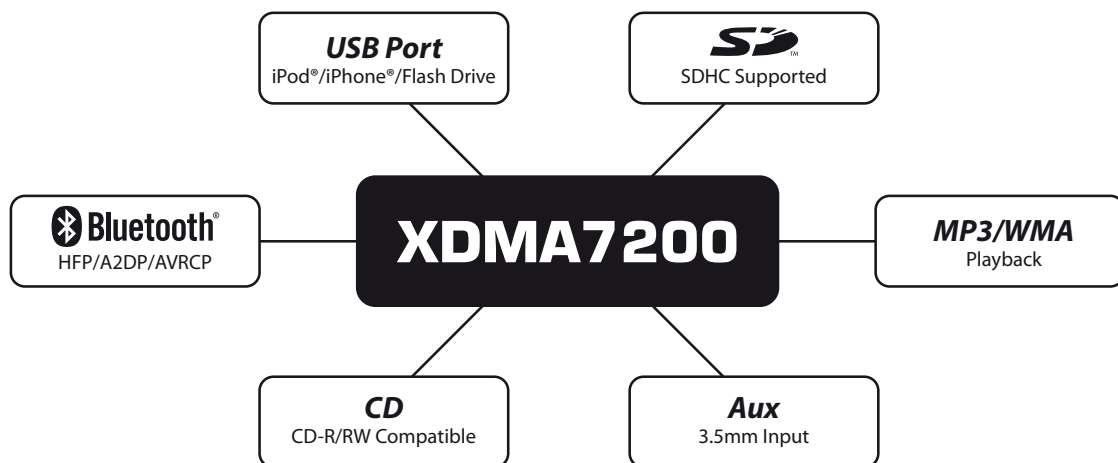

XDMA7200

Preparation

Please read entire manual before installation.

Before You Start

- Disconnect negative battery terminal. Consult a qualified technician for instructions.
- Avoid installing the unit where it would be subject to high temperatures, such as from direct sunlight, or where it would be subject to dust, dirt or excessive vibration.

Getting Started

- Remove trim ring from unit.
- Insert the supplied keys into the slots as shown, and slide the unit out of the mounting sleeve.
- Install mounting sleeve into opening, bending tabs to secure.
- Connect wiring harness and antenna. Consult a qualified technician if you are unsure.
- Certain vehicles may require an installation kit and/or wiring harness adapter (sold separately).
- Test for correct operation and slide the unit into mounting sleeve to secure.
- Snap trim ring into place.

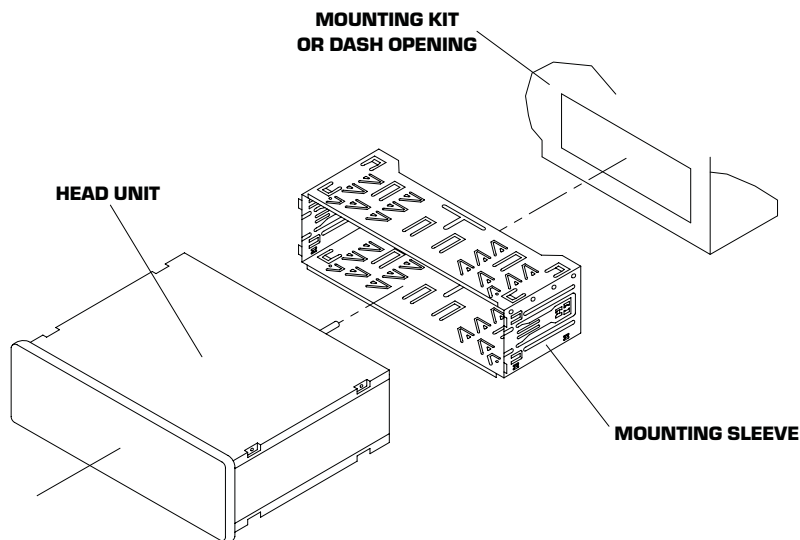
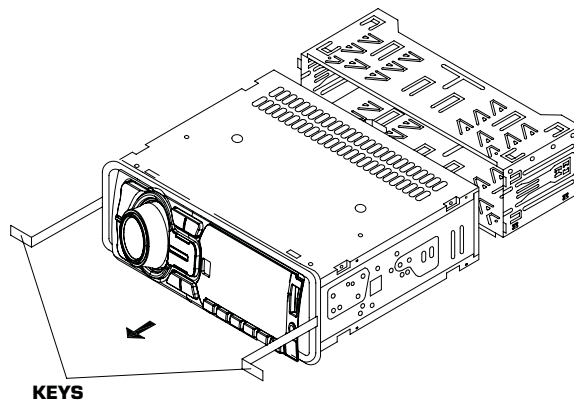

TYPICAL FRONT-LOAD DIN MOUNTING METHOD

XDMA7200

Wiring Diagram

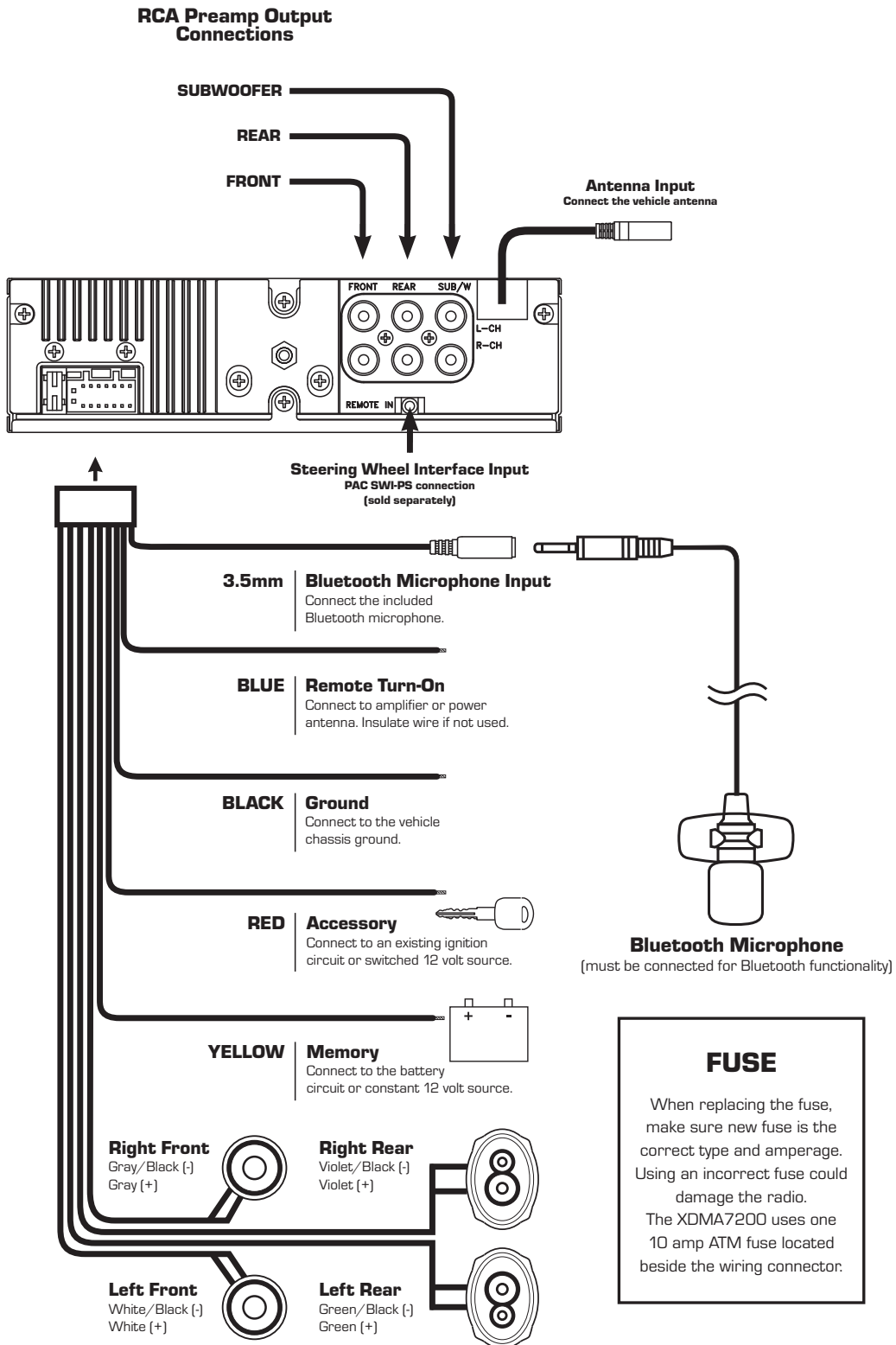

XDMA7200

Receiver - Controls



Control	Function	Description
1	Mode	Changes to another mode of operation.
2	Audio/Menu	Accesses the audio adjustment options. Hold to access the setup menu.
3	Select/Power	Activates music searches. Confirms menu options. Hold to turn the power off.
4	Mute	Mutes the audio output.
5	Bluetooth Talk	Answers phone calls. Accesses Number Dial, Recent Calls and Redial functions.
6	Display	Cycles displayed information. Hold to set the clock.
7	Front USB Port	Connect a USB flash drive, iPod or iPhone device.
8	Open	Opens the front panel to access the reset button, CD and SD card slots.
9	Auxiliary Input	Connect a 3.5mm cable from the headphone output of an MP3 player.
10	Preset 6/Folder Up	Recall/Set preset 6. Changes to the next folder.
11	Preset 5/Folder Down	Recall/Set preset 5. Changes to the previous folder.
12	Preset 4/Play/Pause	Recall/Set preset 4. Cycle between pause/play.
13	Preset 3/Intro	Recall/Set preset 3. Intro menu (plays the first 10 seconds of each song).
14	Preset 2/Random	Recall/Set preset 2. Random menu (shuffles songs in a random playback order).
15	Preset 1/Repeat	Recall/Set preset 1. Repeat menu (repeat the current song, folder or album).
16	Track/Tune Up	Changes to the next song or radio station. Hold to fast forward or seek up.
17	Bluetooth End Call	Ends the current phone call. Hold to disconnect from Bluetooth.
18	Track/Tune Down	Changes to the previous song or radio station. Hold to rewind or seek down.
19	Back	Steps backward or exits music searches or menus.
20	Band	Accesses additional radio presets and cycles between FM and AM radio.

XDMA7200



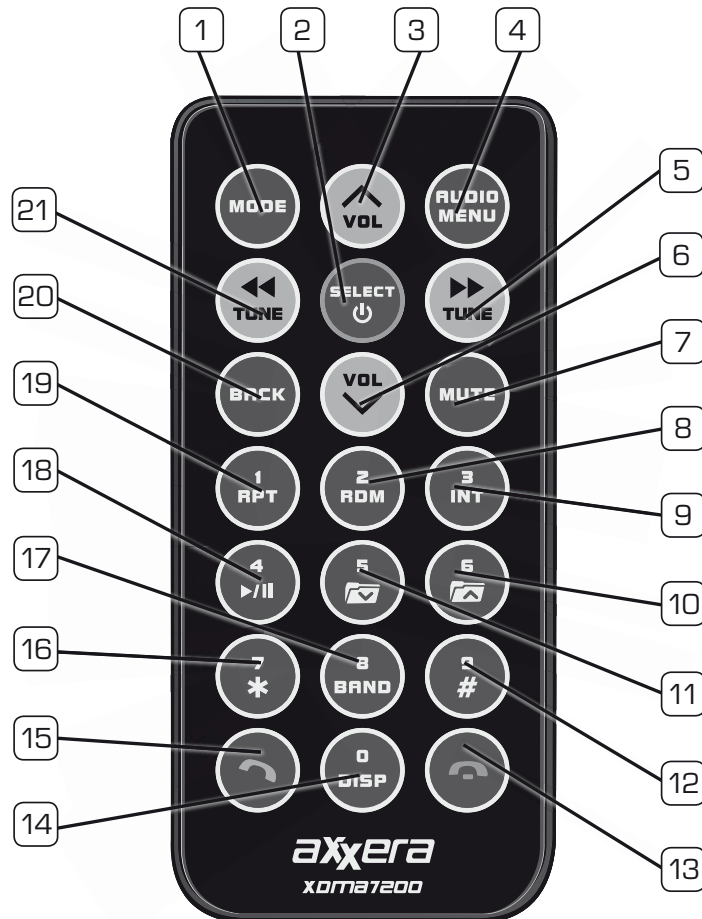

IR Remote - Controls



- | | | | |
|----|----------------------|----|---------------------|
| 1 | Mode | 12 | Key 9/# Key |
| 2 | Select/Power | 13 | End Call |
| 3 | Volume Up | 14 | Key 0/Display |
| 4 | Audio/Menu | 15 | Talk |
| 5 | Tune/Track Up | 16 | Key 7/* Key |
| 6 | Volume Down | 17 | Key 8/Band |
| 7 | Mute | 18 | Preset 4/Play/Pause |
| 8 | Preset 2/Random | 19 | Preset 1/Repeat |
| 9 | Preset 3/Intro | 20 | Back |
| 10 | Preset 6/Folder Up | 21 | Tune/Track Down |
| 11 | Preset 5/Folder Down | | |

XDMA7200

General Operation

Faceplate Removal	Press RELEASE to fold down the front panel. While pushing the front panel left, pull the right side away to remove. To reinstall, slide in bottom left side, then snap left side up and into place.
Power On/Off	Press  or any other button to turn unit on. Press and hold  to turn unit off.
Source	Press MODE to select between AM/FM, CD, auxiliary input, operation of iPod, USB, SD and Bluetooth modes. Modes of operation are indicated in the display. Note: CD mode will not appear unless a CD is inserted. Operation of iPod mode will not appear unless an iPod device has been connected. USB and SD modes will not appear unless a USB device has been connected or SD card has been inserted.
Steering Wheel Interface Input	The steering wheel interface input located on the back of the head unit allows connection to the PAC (Pacific Accessory Corporation) SWI-PS interface module (sold separately). Visit www.pac-audio.com for details. To configure steering wheel controls, follow the instructions provided with the PAC SWI-PS interface module. After installing the interface module, insert the module's 3.5mm jack into the port on the back of the head unit.
Auxiliary Input	Insert 3.5 mm plug to connect your portable audio device.
Volume	Adjust volume using volume knob (00-46).
Mute	Press MUTE to silence the audio. Press MUTE again to cancel.
Reset	Press the RESET button, located behind the front panel, to reset the unit back to the factory settings if abnormal operation occurs.
Display	Press DISP to toggle between items such as clock, radio frequency, or ID3 tag song information.
Set the Clock	With the unit on, press and hold DISP until the clock begins to flash, then release. Press TUNE  to adjust the hours and TUNE  to adjust the minutes. Press DISP momentarily to save the selected time.
12/24-Hour Clock	The clock will display 12-hour AM/PM time in USA frequency spacing mode (PM 10:00). In European frequency spacing mode, the clock will display 24-hour time (22:00).

XDMA7200

Setup Menu

Press and hold **AUDIO/MENU** for more than 3 seconds to access the setup menu, then press **AUDIO/MENU** to cycle through menu options. When desired option appears in the display, rotate the **volume knob** left/right to adjust or activate desired function. Press **BACK** to exit any menu or submenu.

Function	Options	Action
Auto Station Store	AUTO PGM STATIONS	Press SELECT to begin automatically programming strong radio stations to the 6 preset buttons in the current band. (Tuner mode only)
Local/Distance Tuning	LOCAL OFF	Activates distance tuning. (Tuner mode only)
	LOCAL ON	Activates local tuning for strong station reception only. (Tuner mode only)
Tuner Frequency Spacing	FREQ USA	Programs the unit to USA tuner spacing. (200kHz for FM and 10kHz for AM). (Tuner mode only)
	FREQ EUR	Programs the unit to European tuner spacing. (50kHz for FM and 9kHz for AM). (Tuner mode only)
Selectable iPod Control	IPOD CNT FULL	Programs the head unit to advanced control of the iPod/iPhone device.
	IPOD CNT MANUAL	Programs the head unit to basic control of the iPod/iPhone device and allows music to be controlled from the iPod/iPhone device.
Loudness Curve	LOUD OFF	Disables the loudness function.
	LOUD ON	Enables the loudness function. Activating this feature will enhance the bass and treble frequencies when listening to music at low volumes.
Clock Display	CLOCK OFF	Programs unit to not display the clock when the power is off.
	CLOCK ON	Programs unit to display the clock when the power is off.
Auxiliary Input	AUX IN ON	Enables the front panel 3.5mm auxiliary input.
	AUX IN OFF	Disables the auxiliary input.
Beep Confirmation	BEEP OFF	Disables the confirmation beep.
	BEEP ON	Enables the confirmation beep.
Programmable Turn On Volume	PRO VOL #	Programs unit to always turn on at a specific volume (default is OFF). Any volume level 1-46 can be selected.
Power on Message	MESSAGE OFF	Disables power on message. (example: GOOD MORNING)
	MESSAGE ON	Enables power on message to be displayed.
Scrolling Option	SCROLL 15 SEC	Programs unit to scroll information once every 15 seconds.
	SCROLL ONCE	Programs unit to scroll once, then show first 10 characters on display.
	SCROLL ON	Programs unit to scroll continuously.
	SCROLL OFF	Programs unit to show the first 10 characters on the display.
Illumination Dimmer	DIMMER HIGH	Programs unit to the brightest illumination level.
	DIMMER MEDIUM	Programs unit to the middle illumination level.
	DIMMER LOW	Programs unit to the dimmest illumination level.
Demonstration Mode	DEMO OFF	Disables the demonstration mode.
	DEMO ON	Enables the demonstration message.

Note: See page 22 for Bluetooth setup menu options.

XDMA7200

Audio Menu

Press **AUDIO/MENU** momentarily to cycle between Bass, Treble, Balance, Fader, Equalizer, Subwoofer, High Pass Filter and Source Volume Level. Press **BACK** at any time to exit the audio menu.

→ **BASS** → **TREBLE** → **BALANCE** → **FADER** → **EQ** → **SUBWOOFER** → **SOURCE LEVEL** →

Bass	Press AUDIO/MENU until BASS appears, then rotate the volume knob left/right to adjust (-6 minimum / +6 maximum).
Treble	Press AUDIO/MENU until TREBLE appears, then rotate the volume knob left/right to adjust (-6 minimum / +6 maximum). Note: Bass and Treble settings are retained for each mode individually.
Balance	Press AUDIO/MENU until BALANCE appears, then rotate the volume knob left/right to adjust (BALANCE LEFT 12 to BALANCE RIGHT 12). "BALANCE EVEN" represents equal balance.
Fader	Press AUDIO/MENU until FADER appears, then rotate the volume knob left/right to adjust (FADER FRONT 12 to FADER REAR 12). "FADER EVEN" represents equal fader.
EQ	Press AUDIO/MENU until EQ appears. Rotate the volume knob left/right to select between FLAT (default), POP, JAZZ, CLASSIC, BEAT, ROCK and USER equalization curves. Press SELECT to confirm. Any manual adjustment to the Bass, Middle or Treble settings are automatically saved as USER.
Subwoofer	Press AUDIO/MENU until SUBWFR appears, then press SELECT to confirm. Rotate the volume knob left/right to adjust (0-12). Adjusting the level to 0 turns the subwoofer off.
Source Volume Level	The source volume level control allows a gain adjustment for each audio source. Set the source volume level for each mode, depending on the relative volume of each audio source. To set the source volume level, press AUDIO/MENU until "SOURCE LEVEL" appears. After one second, the current mode will appear on the display. Turn the volume knob to adjust the audio level of the current source (-6 minimum/+6 maximum). Note: Only the current mode will be available for adjustment. Change to another mode to set the source level for that mode.

XDMA7200

LCD Icon Layout

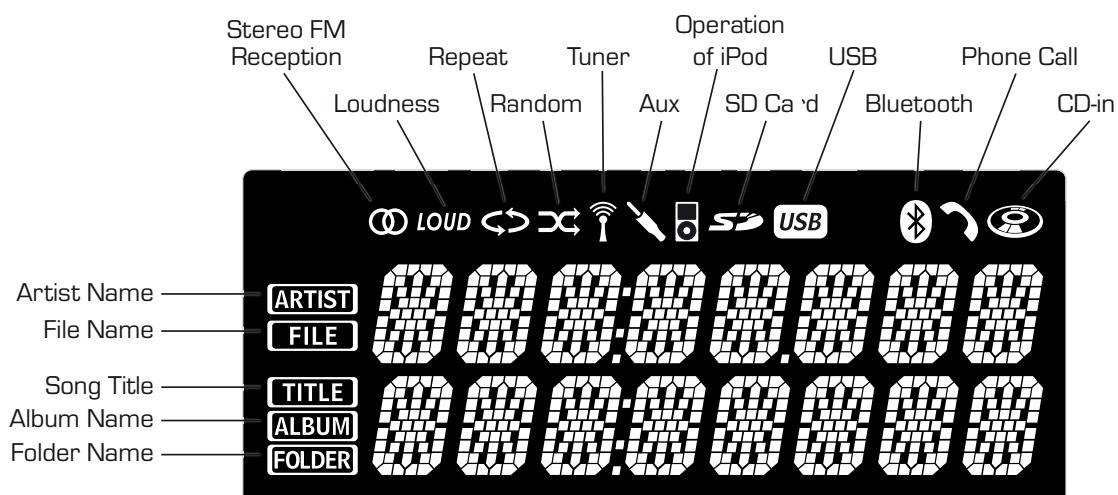

AM/FM Tuner Operation

Seek Tuning

Press **TUNE** ◀◀ or **TUNE** ▶▶ for more than one second to seek the next strong station.

Manual Tuning

Press **TUNE** ◀◀ or **TUNE** ▶▶ momentarily to move radio frequency up or down one step at a time. Press and hold to advance quickly.

Band

Press **BAND** to select between FM1, FM2, FM3, AM1 and AM2 bands. Up to six presets can be programmed for each band.

Storing and Recalling Station Presets

Up to 18 FM stations and 12 AM stations can be stored in memory. To store a station, select the desired band and station. Press and hold the desired preset button (1-6) for more than two seconds. When stored, the preset number will appear in the display. The station can be recalled by pressing the corresponding preset button.

XDMA7200

CD Player Operation - Audio CDs

Insert CD	Fold down front panel to access the CD slot. With the label facing up, insert a standard size CD into the CD slot. The CD will automatically begin playback.
Eject CD	Fold down front panel and press EJECT to eject the CD. The unit will change to previous mode of operation. If the disc is not removed within 10 seconds, the unit will reload the disc. The unit does not have to be turned on to eject CD.
Track Select	Press TRACK ►► to skip to the beginning of the next track. Press TRACK ◄◄ to return to the beginning of the current track. Pressing TRACK ◄◄ again skips to the beginning of the previous track.
Fast Forward/Reverse	Press and hold TRACK ►► or TRACK ◄◄ to fast forward or reverse a track.
Pause	Press ►/ to temporarily stop CD playback. Press ►/ again to resume playback.
Intro	Press INT to enter the Intro menu, then turn the volume knob to select one of the following options: <ul style="list-style-type: none">• OFF - Cancels the INT function.• ALL - Plays the first 10 seconds of each track.
Repeat	Press RPT to enter the Repeat menu, then turn the volume knob to select one of the following options: <ul style="list-style-type: none">• ALL - Plays all tracks on CD.• TRACK - Continuously repeats selected track.
Random	Press RDM to enter the Random menu, then turn the volume knob to select one of the following options: <ul style="list-style-type: none">• OFF - Cancels the RDM function.• ALL - Plays all tracks in random order.
CD-R/CD-RW Compatibility	<p>Some CD-Rs and CD-RWs may be incompatible with this unit, depending on media type and recording method. In addition, the following CDs may be incompatible with this unit:</p> <p>CDs exposed to extreme temperatures or direct sunlight for extended periods of time, CDs recorded in which a recording session failed or a re-recording was attempted and, or encrypted or copy-protected CDs which do not conform to the audio CD-DA red book recording standard.</p>



XDMA7200

CD Player Operation - MP3/WMA

Playing an MP3/WMA Disc

When an MP3/WMA encoded disc is first inserted, "READING" will appear in the display. Depending on the number of files and folders, this may take several seconds.

Folder Access

Press  to select the next folder.
Press  to select the previous folder.

*Folder access is only available on discs recorded with more than one folder.

Repeat

Press **RPT** to enter the Repeat menu, then turn the **volume knob** to select one of the following options:

- ALL - Plays all tracks on CD.
- SONG - Continuously repeats selected track.
- FOLDER - Continuously repeats all files in the folder.

Random

Press **RDM** to enter the Random menu, then turn the **volume knob** to select one of the following options:

- OFF - Cancels the **RDM** function.
- ALL - Plays all tracks in random order.
- FOLDER - Plays all tracks in the folder in random order.

Note: Random mode is retained in memory when selecting between other modes and when the unit is turned on/off.

Intro

Press **INT** to enter the Intro menu, then turn the **volume knob** to select one of the following options:

- OFF - Cancels the **INT** function.
- ALL - Plays first 10 seconds of each track.
- FOLDER - Plays first 10 seconds of each track in folder.

Note: Folder repeat, random and intro options only function on MP3/WMA discs recorded with more than one folder.

Displaying Information

Press **DISP** momentarily to select between artist/song title (default), file/folder name, track number/clock & elapsed time.

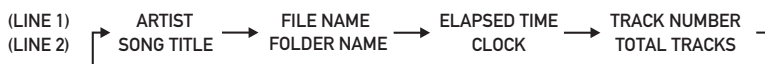

"NO ARTIST", "NO TITLE", or "NO ALBUM" will be displayed if the file contains no ID3 tag information.

"ROOT" will be displayed if the directory name of a root folder is not labeled.

XDMA7200

CD Player Operation - MP3/WMA

File/Folder Search

- Begin Searching** Press **SELECT** to enter the file/folder search mode. A list of all the folders from the CD will be displayed.
- Note:** Any files located in the root directory will be located in the folder named "ROOT".
- Choose a song** Turn the **volume knob** to cycle through all the folders on the CD and press **SELECT** to choose the desired folder. The list of files in the selected folder will be displayed. Turn the **volume knob** to cycle through the list of files.
- Menu Navigation** Pressing **ESC** when viewing the contents of a folder will return to the list of folders on the CD. Press **ESC** again to exit the search menu.
- Playing a song** Once the desired song is displayed, press **SELECT** to begin playback of the desired song.

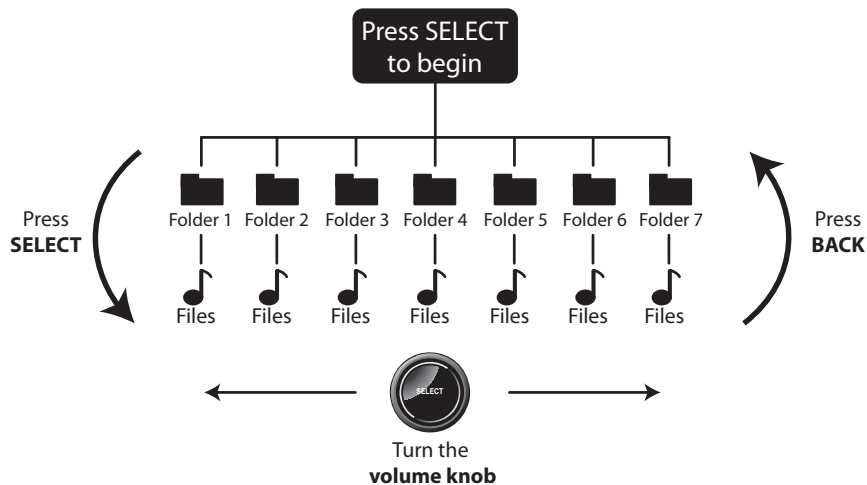

XDMA7200

CD Player Operation - MP3/WMA

File/Folder Compatibility and Support

Type	Specification
Compatible File Types	<ul style="list-style-type: none">• CD-ROM (ISO), CD-R, CD-RW• CD-DA (digital audio)• MP3 data (.mp3)• WMA data (.wma)
Incompatible File Types	<ul style="list-style-type: none">• DRM protected files• WMA lossless• Apple lossless• WMA Pro• MP3 Pro• MP3 playlists• WAV lossless• M4A/AAC data
Recording Format Compatibility	<ul style="list-style-type: none">• ISO9660 level 1 & level 2• Yellow book MODE 1 & MODE 2 FORM 1• Multi session
Sampling Frequency Rate Compatibility	<ul style="list-style-type: none">• MP3: 8kHz - 48kHz• WMA: 32kHz - 48kHz
Transfer Bit Rate Compatibility	<ul style="list-style-type: none">• MP3: 32kbps - 320kbps• WMA: 32kbps - 192kbps
Character Support	<ul style="list-style-type: none">• Song Title: 32 characters• Artist Name: 32 characters• Album Name: 32 characters• File Name: 32 characters• Folder Name: 32 characters
ID3 Tag Support	<ul style="list-style-type: none">• MP3 Tags: Version 1.0 - 2.4• WMA Tags
File/Folder Limit	<ul style="list-style-type: none">• Maximum files: 999• Maximum folders: 255• Maximum folder levels: 8

XDMA7200

Operation of iPod/iPhone

Connecting an iPod/iPhone Device

USB Connection



Using the "dock connector to USB" sync cable (provided with the iPod/iPhone device), plug the USB cable the XDMA7200's USB port. Once connected, playback will begin automatically.

Controlling a Device: Full Control

When the control of iPod/iPhone feature is set to "FULL" in the Setup Menu, use the following functions to control the device:

Song Select

Press **▶▶** to skip to the beginning of the next song.
Press **◀◀** to return to the beginning of the current song.
Pressing **◀◀** again skips to the beginning of the previous song.

Fast Forward and Reverse

Press and hold **▶▶** or **◀◀** to fast forward or reverse a song.

Pause

Press **▶/||** to temporarily stop playback.
Press **▶/||** again to resume playback.

Repeat

Press **RPT** to enter the Repeat menu, then turn the **volume knob** to select one of the following options:

- ALL - Repeats all tracks.
- SONG - Repeats selected track.

Random

Press **RDM** to enter the Random menu, then turn the **volume knob** to select one of the following options:

- OFF - Cancels the **RDM** function.
- ALL - Plays all tracks in random order.
- ALBUM - Plays all tracks in the selected album in random order.

Intro

Press **INT** to enter the Intro menu, then turn the **volume knob** to select one of the following options:

- OFF - Cancels the **INT** function.
- ON - Plays first 10 seconds of each track.

XDMA7200

Operation of iPod/iPhone

Controlling a Device: Full Control - Music Search

The XDMA7200 features a powerful music search that simplifies the searching process. Follow the steps below to find the desired song:

- Begin Searching** | Press **SELECT** to begin the search. The main search menu will appear.
- Select a Category** | Turn the **volume knob** to select between **playlist, artist, album, song, podcast and audiobook**. Press **SELECT** to select the desired search category. Some categories have subcategories to navigate through. See the table below for details.

Search Category	Menu Navigation
Playlist	Menu → Playlists → Songs
Artist	Menu → Artists → Albums → Songs
Album	Menu → Albums → Songs
Song	Menu → Songs
Audiobook	Menu → Audiobooks
Podcast	Menu → Podcasts

- Step Backwards** | Press **BACK** to return to the previous menu, or exit the search menu when the main menu is shown.
- Playing a Song** | Navigate to the desired song/podcast/audiobook and press **SELECT** to begin playback.

Note: If a specific category is selected, the iPod/iPhone device playback will be limited to that category until another category is selected in the search menu.

Displayed Information

- Displaying Information** | Press **DISP** momentarily to select file/folder name (default), song title/artist, track number/clock & elapsed time.

(LINE 1)	ARTIST	→	ARTIST	→	ELAPSED TIME	→	TRACK NUMBER
(LINE 2)	SONG TITLE	→	ALBUM	→	CLOCK	→	TOTAL TRACKS
- Character Support** | Maximum character display information
 - *Song Title - 32 character maximum
 - *Artist Name - 32 character maximum
 - *Album Name - 32 character maximum

*Song Title, Artist Name and Album Name will only be displayed if included with the file.

XDMA7200

Operation of iPod/iPhone

Controlling a Device: Manual Control

When the control of iPod/iPhone feature is set to "MANUAL" in the iPod Menu, use the following functions to control the device:

Manual Control for iPod	When "MANUAL" control for iPod is selected from the Setup Menu, the iPod or iPhone device can be controlled directly from the device's interface. All functions except for volume can be used from the iPod or iPhone device.
Basic Head Unit Control	In addition to manual control of the iPod/iPhone device, the following basic functions are still active:
Song Select	Press ►► to skip to the beginning of the next song. Press ◄◄ to return to the beginning of the current song. Pressing ◄◄ again skips to the beginning of the previous song.
Pause	Press ►/ to temporarily stop playback. Press ►/ again to resume playback.
Volume	When playing an iPod device, the volume is adjustable using the volume controls on inside panel.
Compatibility	To be compatible with manual control mode, the iPod/iPhone device must be update with the latest firmware using iTunes. See the list below for compatibility details.

Device Compatibility

- | | |
|-----------------|---|
| Made for | <ul style="list-style-type: none">• iPod touch (4th generation)• iPod nano (6th generation)• iPod touch (3rd generation)• iPod nano (5th generation)• iPod touch (2nd generation)• iPod nano (4th generation)• iPod classic• iPod touch (1st generation)• iPod nano (3rd generation)• iPod nano (2nd generation)• *iPod nano (1st generation)• *iPod with video• iPhone 4• iPhone 3GS• iPhone 3G• iPhone |
|-----------------|---|

*These iPod devices are not compatible with manual control mode.

XDMA7200

USB/SD Card Operation

Connect a USB Device (sold separately)

To play MP3/WMA files from most mass storage devices, connect a device to the XDMA7200's USB port.



Connect an SD Card (sold separately)

To play MP3/WMA files from an SD Card, insert an SD card into the XDMA7200's SD card slot, located behind the front panel. Insert the SD card with the label facing to the left, and press the card until it clicks into place. Remove the SD card by pressing in until it clicks, then pull to remove.



Playing Music

When a USB or SD card device is first connected, playback will begin momentarily. Depending on the number of files and folders, it may take several seconds for the device to begin playing. If no valid MP3/WMA files are detected, "NO FILE" will be displayed and the last mode will be resumed.



Track Select

Press **TRACK**  to skip to the beginning of the next track. Press **TRACK**  to return to the beginning of the current track. Pressing **TRACK**  again skips to the beginning of the previous track.



Fast Forward and Reverse

Press and hold **TRACK**  or **TRACK**  to fast forward or reverse a track.

Pause

Press  to temporarily stop USB playback. Press  again to resume playback.

Folder Access

Press  to select the next folder.
Press  to select the previous folder.

Note: Folder access is only available on USB/SD Card devices with more than one folder.

Repeat

Press **RPT** to enter the Repeat menu, then turn the **volume knob** to select one of the following options:

- ALL - Plays all tracks on the USB/SD Card device.
- TRACK - Continuously repeats selected track.
- FOLDER - Continuously repeats all files in selected folder.

Random

Press **RDM** to enter the Random menu, then turn the **volume knob** to select one of the following options:

- OFF - Cancels the **RDM** function.
- ALL - Plays all tracks in random order.
- FOLDER - Plays all tracks in folder in random order.

Note: Random mode is retained in memory when selecting between other modes and when the unit is turned on/off.

Intro

Press **INT** to enter the Intro menu, then turn the **volume knob** to select one of the following options:

- OFF - Cancels the **INT** function.
- ALL - Plays first 10 seconds of each track.
- FOLDER - Plays first 10 seconds of each track in folder.

XDMA7200

USB/SD Card Operation

File/Folder Search

- Begin Searching** Press **SELECT** to enter the file/folder search mode. A list of all the folders from the USB device will be displayed.
- Note:** Any files located in the root directory will be located in the folder named "ROOT".
- Choose a song** Turn the **volume knob** to cycle through all the folders on the device and press **SELECT** to choose the desired folder. The list of files in the selected folder will be displayed. Turn the **volume knob** to cycle through the list of files.
- Menu Navigation** Pressing **ESC** when viewing the contents of a folder will return to the list of folders on the USB device. Press **ESC** again to exit the search menu.
- Playing a song** Once the desired song is displayed, press **SELECT** to begin playback of the desired song.

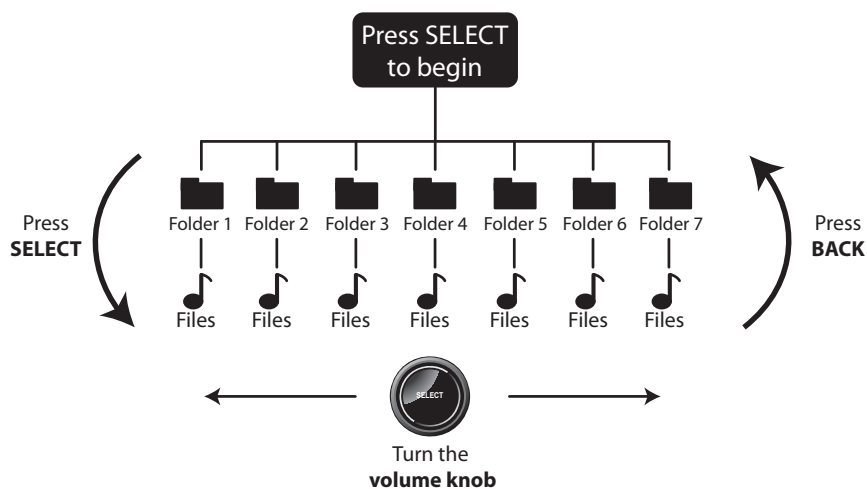

Displayed Information

Press **DISP** momentarily to select between artist/song title (default), file/folder name track number/clock & elapsed time.

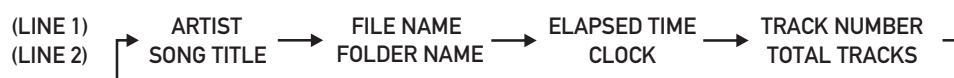

XDMA7200

USB / SD Card Operation

File/Folder Compatibility and Support

Type	Specification
Compatible File Types	<ul style="list-style-type: none">• MP3 data (.mp3)• WMA data (.wma)
Incompatible File Types	<ul style="list-style-type: none">• DRM protected files• WMA lossless• Apple lossless• WMA Pro• MP3 Pro• MP3 playlists• M4A/AAC data• WAV lossless
Sampling Frequency Rate Compatibility	<ul style="list-style-type: none">• MP3: 8kHz - 48kHz• WMA: 32kHz - 48kHz
Transfer Bit Rate Compatibility	<ul style="list-style-type: none">• MP3: 32kbps - 320kbps• WMA: 32kbps - 192kbps
Character Support	<ul style="list-style-type: none">• Song Title: 32 characters• Artist Name: 32 characters• Album Name: 32 characters• File Name: 32 characters• Folder Name: 32 characters
ID3 Tag Support	<ul style="list-style-type: none">• MP3 Tags: Version 1.0 - 2.4• WMA Tags
File/Folder Limit	<ul style="list-style-type: none">• Maximum number of files: 50000• Maximum number of folders: 255 (plus the root folder)• Maximum number of files in each folder: 50000 <p>Note: For devices with more than the maximum number of files/folders, some files will be ignored and may not function properly.</p>
USB/SD File System	<ul style="list-style-type: none">• FAT/FAT32 file system supported.• HFS/NTFS/EXT2/EXT3 not supported.
SD Card Capacity	16GB or less supported.

XDMA7200

Bluetooth® Operation

Pairing a Device

Preparation

Before you can use a Bluetooth device, it must be paired and connected. Make sure that Bluetooth is activated on your device before you begin the pairing process.

Pairing a New Device

The XDMA7200 broadcasts the pairing signal constantly when no devices are currently connected. Complete the pairing sequence from your Bluetooth device. Refer to the owner's manual for your device for more details.

**The device name is "DUAL BT"
The Bluetooth passcode "1234"**



Note: The XDMA7200 can be in any mode of operation when pairing is performed.

Pairing Additional Devices

If a device is currently connected, press and hold  to disconnect the current device before a new device can be paired. Then begin the pairing sequence from the new Bluetooth device.

Connecting a Paired Device

Most Bluetooth devices support the auto-connect feature, and will connect automatically if the device is in range when the XDMA7200 is powered-on. If your device was previously paired but does not connect, use these instructions below.

- If your most recently connected Bluetooth device becomes disconnected or does not reconnect, press  from Bluetooth mode to reconnect your mobile device.
- To connect a previously paired device that was not recently connected:
 - 1) If applicable, press and hold  to disconnect any connected mobile devices.
 - 2) From Bluetooth mode, press **SELECT**. "Paired Devices" will appear on the LCD.
 - 3) Turn the volume knob to cycle through the list of devices.
 - 4) Press **SELECT** or  to connect to the desired device. It must be in range to connect.

Note: If the **Auto Connect** setup menu setting is set to **OFF**, you must press  to connect you device after pairing, and each time the XDMA7200 is powered on.

Disconnecting a Device



Press and hold  for 3 seconds to disconnect a connected device. The device will remain paired and appear in the PAIRED DEVICES menu, but not be connected.

XDMA7200

Bluetooth® Operation

Making a Phone Call

Manual Dialing

- Press  once. "Enter Number" will be shown, then an " " will appear on the display.
- Using the remote control, enter the phone number using the 0-9 buttons. Press  on the remote control or XDMA7200 front panel to begin dialing.

Note: Placing a phone call from your cell phone will also use the Bluetooth function of the XDMA7200.

Recent Calls List

- Press **SELECT** from Bluetooth mode to view the 10 most recent phone calls that were dialed, received or missed while connected to the XDMA7200.
- Turn the volume knob to cycle through the recent phone numbers. Press **SELECT** or  to dial the phone number.

Redialing the last number



To redial the last phone number, press  three times from Bluetooth mode. Dialing will begin automatically.

Receiving and Ending Phone Calls

Receiving a Phone Call

Incoming phone calls will automatically appear on the display and a ring tone will be heard.

Note: The volume of the ring tone depends on the volume level of the XDMA7200. The incoming ring tone may not be heard if the volume is set to a low level or mute is activated.

- Press  to receive the incoming phone call.
- Press  to refuse the incoming phone call.

Note: If **Auto Answer** is set to **ON** in the setup menu, all phone calls will be received automatically.





Ending a Phone Call

During an active phone call, press  to end a phone call. If the phone call was received when listening to music in another mode, the XDMA7200 will resume the previous mode.

XDMA7200

Bluetooth® Operation

During a Phone Call

Volume	Turn the volume knob to adjust the volume level during a phone call. Bluetooth mode has a separate volume level from the main volume of other modes. The XDMA7200 will remember the volume level in Bluetooth mode and always return to the last volume level for each phone call.
Microphone Mute	Press MUTE during a phone call to turn the XDMA7200's external microphone off. Press MUTE again to resume microphone operation.
Audio Transfer	Press DISP during a phone call to transfer the call from the XDMA7200 to the cell phone. Press DISP again to toggle the audio back to the XDMA7200.
Call Waiting	During a phone call, if there is a second incoming call, press  to place the first call on hold and switch to the second phone call. Press  again to switch back to the first call.
Call Hold	During a phone call, when there are no additional incoming calls, press  to place the call on hold. Press  again to resume the phone call.
Note: Audio transfer, call waiting and call hold must be supported by the mobile phone and service provider to function properly.	

Bluetooth Setup Menu Options

Function	Options	Action
Bluetooth	BL'TOOTH (ON/OFF)	Enables/disables Bluetooth functionality.
Auto Connect	AUTO CON (ON/OFF)	Set to ON to allow a Bluetooth device to connect automatically. Setting to OFF requires manually connecting the device.
Auto Answer	AUTO ANS (OFF/ON)	When set to ON, every incoming phone call will automatically be answered after 2-3 rings. When set to OFF, the  button must be pressed to answer incoming phone calls.
Speaker Output	BT SPRKS (FRONT/ALL)	Set to FRONT to direct the Bluetooth audio output to the front speakers only. Set to ALL to enable Bluetooth audio to output from all 4 speakers.

XDMA7200

Bluetooth® Operation

Streaming Audio Operation

The XDMA7200 supports A2DP (advanced audio distribution profile) wireless streaming audio from your Bluetooth mobile device directly to your head unit. You can also control your music from the front panel of the head unit using AVRCP (audio video remote control profile).

Notes:

- To stream music to your head unit, your mobile device must support the A2DP and AVRCP Bluetooth profiles. Check the owner's manual of your mobile device for details.
- Streaming audio must be enabled from your mobile device. This option will vary depending on the device. Some devices allow streaming audio to be disabled.

After pairing, connecting and enabling streaming audio from a compatible mobile device, begin playing music using the music player on your mobile device. Once the music is playing, the following functions can be used to control the music:

- The ►► button will skip to the next available audio track.
- The ◀◀ button will skip to the previous audio track.
- The ►/|| button will toggle between play and pause during playback.
- The ⏻ button will stop the audio playback.

Note: Some Bluetooth devices may not fully support these commands.

Bluetooth Reset

Resetting the Bluetooth module will remove the list of paired phones and delete the list of recent calls from memory.

To reset Bluetooth, perform the following steps:

- 1) Press **MODE** until the head unit is in Bluetooth mode.
- 2) Press and hold **MENU** for 3 seconds to reset the Bluetooth settings back to the factory default.

Compatibility Note:

Due to the differences in Bluetooth technology, some mobile devices may be incompatible, function improperly or may not support all features when used with the XDMA7200.

XDMA7200

Limited One Year Warranty

This warranty gives you specific legal rights. You may also have other rights which vary from state to state.

Dual Electronics Corp. warrants this product to the original purchaser to be free from defects in material and workmanship for a period of one year from the date of the original purchase.

Dual Electronics Corp. agrees, at our option, during the warranty period, to repair any defect in material or workmanship or to furnish an equal new, renewed or comparable product (whichever is deemed necessary) in exchange without charges, subject to verification of the defect or malfunction and proof of the date of purchase. Subsequent replacement products are warranted for the balance of the original warranty period.

Who is covered? This warranty is extended to the original retail purchaser for products purchased from an authorized Dual dealer and used in the U.S.A.

What is covered? This warranty covers all defects in material and workmanship in this product. The following are not covered: software, installation/removal costs, damage resulting from accident, misuse, abuse, neglect, product modification, improper installation, incorrect line voltage, unauthorized repair or failure to follow instructions supplied with the product, or damage occurring during return shipment of the product. Specific license conditions and copyright notices for the software can be found via axxera.dualav.com.

What to do?

1. Before you call for service, check the troubleshooting guide in your owner's manual. A slight adjustment of any custom controls may save you a service call.
2. If you require service during the warranty period, you must carefully pack the product (preferably in the original package) and ship it by prepaid transportation with a copy of the original receipt from the retailer to an authorized service center.
3. Please describe your problem in writing and include your name, a return UPS shipping address (P.O. Box not acceptable), and a daytime phone number with your shipment.
4. For more information and for the location of the nearest authorized service center please contact us by one of the following methods:
 - Call us toll free at 1 866 382 5476
 - E mail us at cs@dualav.com

Exclusion of Certain Damages: This warranty is exclusive and in lieu of any and all other warranties, expressed or implied, including without limitation the implied warranties of merchantability and fitness for a particular purpose and any obligation, liability, right, claim or remedy in contract or tort, whether or not arising from the company's negligence, actual or imputed. No person or representative is authorized to assume for the company any other liability in connection with the sale of this product. In no event shall the company be liable for indirect, incidental or consequential damages.

XDMA7200

Troubleshooting - General

Problem	Cause	Action
Unit will not turn on (no power)	Yellow wire not connected or incorrect voltage Red wire not connected or incorrect voltage	Check connections for proper voltage (11-16VDC)
	Black wire not connected	Check connection to ground
	Fuse blown	Replace fuse
Unit has power (but no sound)	Speaker wires not connected	Check connections at speakers
	One or more speaker wires touching each other or touching chassis ground	Insulate all bare speaker wires from each other and chassis ground
Unit blows fuses	Yellow or red wire touching chassis ground	Check for pinched wire
	Speaker wires touching chassis ground	Check for pinched wire
	Incorrect fuse rating	Use fuse with correct rating
Excessive Skipping	Unit is not mounted correctly or backstrap is not secure	Check mounting sleeve and backstrap support
	Physical defect in CD, CD-R/RW disc	Check media for scratches
ERROR-02 appears on display	Disc read error or disc is in upside down	Press EJECT or RESET
CD will not eject	CD mechanism error	Hold EJECT for 3 seconds to force eject the CD
PROTECT appears on display	The WMA file is copy-protected by DRM (Digital Rights Management)	Write disc using WMA files that are not copy-protected
NO FILE appears on display	Selected file is not available in direct or alphanumeric search modes	Repeat search using valid parameters
NO SUPPORT appears on display	An invalid ID3 tag version is present	Version 1.0 to 2.4 ID3 tags are supported.

XDMA7200

Specifications

FM Tuner	Tuning range: 87.5MHz - 107.9MHz Usable sensitivity: 8.5dBf 50dB quieting sensitivity: 10dBf Stereo separation @ 1kHz: 40dB Frequency response: 30Hz - 13kHz
AM Tuner	Tuning range: 530kHz - 1710kHz Usable sensitivity: 22uV Frequency response: 30Hz - 2.2kHz
General	Speaker output impedance: 4 to 8 ohms Line output voltage: 2 Volts RMS Dimensions: 7" x 7" x 2" (178 x 178 x 51 mm)
USB/SD Card	File system: FAT, FAT32 File extensions support: .mp3, .wma SD Card maximum device capacity: 16GB
Bluetooth® Profiles	HFP (hands-free profile) A2DP (advanced audio distribution profile) AVRCP (audio video remote control profile)

Design and specifications subject to change without notice.



CEA 2006 Power Standard Specifications (reference: 14.4VDC +/- 0.2V, 20Hz - 20kHz)

Power Output: 18 Watts RMS x 4 channels at 4 ohms and $\leq 1\%$ THD+N
Signal to Noise Ratio: 80dBA (reference: 1 watt into 4 ohms)

XDMA7200

FCC Compliance

This device complies with Part 15 of the FCC Rules. Operation is subject to the following two conditions:

(1) this device may not cause harmful interference, and

(2) this device must accept any interference received, including interference that may cause undesired operation.

Warning: Changes or modifications to this unit not expressly approved by the party responsible for compliance could void the user's authority to operate the equipment.

Note: This equipment has been tested and found to comply with the limits for a Class B digital device, pursuant to Part 15 of the FCC Rules. These limits are designed to provide reasonable protection against harmful interference in a residential installation. This equipment generates, uses and can radiate radio frequency energy and, if not installed and used in accordance with the instructions, may cause harmful interference to radio communications. However, there is no guarantee that interference will not occur in a particular installation. If this equipment does cause harmful interference to radio or television reception, which can be determined by turning the equipment off and on, the user is encouraged to try to correct the interference by one or more of the following measures:

- Reorient or relocate the receiving antenna.
- Increase the separation between the equipment and receiver.
- Connect the equipment into an outlet on a circuit different from that to which the receiver is connected.
- Consult the dealer or an experienced radio/TV technician for help.



Dual Electronics Corp.
Toll Free: 1-866-382-5476
axxera.dualav.com

©2011 Dual Electronics Corp. All rights reserved.

iPhone, iPod, iPod classic, iPod nano, and iPod touch are trademarks of Apple Inc., registered in the U.S. and other countries.

"Made for iPod" and "Made for iPhone" mean that an electronic accessory has been designed to connect specifically to iPod or iPhone, respectively, and has been certified by the developer to meet Apple performance standards. Apple is not responsible for the operation of this device or its compliance with safety and regulatory standards. Please note that the use of this accessory with iPod or iPhone may affect wireless performance.

The Bluetooth® word mark and logos are owned by the Bluetooth SIG, Inc. and any use of such marks by Namsung is under license.

The SD logo is a trademark of the SD Card Association.

Other trademarks and trade names are those of their respective owners.

NSA0611-V01